

NOTICE DE MONTAGE
INSTRUCTIONS FOR ASSEMBLY
MONTAGEANLEITUNG
GEBRUIKSAANWIJZING
ISTRUZIONI DI MONTAGGIO
INSTRUCCIONES DE MONTAJE
INSTRUÇÕES DE MONTAGEM

buronomic
FABRICANT FRANÇAIS
N° DV40746/03

CONCEPTION ET REALISATION BUREAU D'ETUDES BURONOMIC

GARANTIE (vices cachés)
_ Référence produit à nous communiquer impérativement en cas de litige :
Voir étiquette apposée au dos du produit

GARANTIE (defekt)
_ In the event of complaint, it is essential to mention the product reference :
See label affixed to the back of the product.

GARANTIE (fabrikationsfeil)
_ Im streifall sit uns die produktreferenz mitzuteilen :
Siehe etikett auf produckruckseite.

WAARBORG (de verborgen gebreken)
_ Vermeld in geval van klachten altijd het productnummer :
Zie label op de achterzijde van het product

GARANZIA (vizi occulti)
_ Specificare obbligatoriamente il riferimento prodotto in caso di contestazioni :
Si veda l'etichetta applicata dietro il prodotto

GARANTIA (defectos ocultos)
_ Referencia de producto citese obligatoriamente en caso de reclamacion :
Ver etiqueta en la parte posterior del producto.

GARANTIA (vices ocultas)
_ Em caso de reclamação indiqu-nos imperativamente a referência do produto :
Ver etiqueta fixada na parte posterior do produto

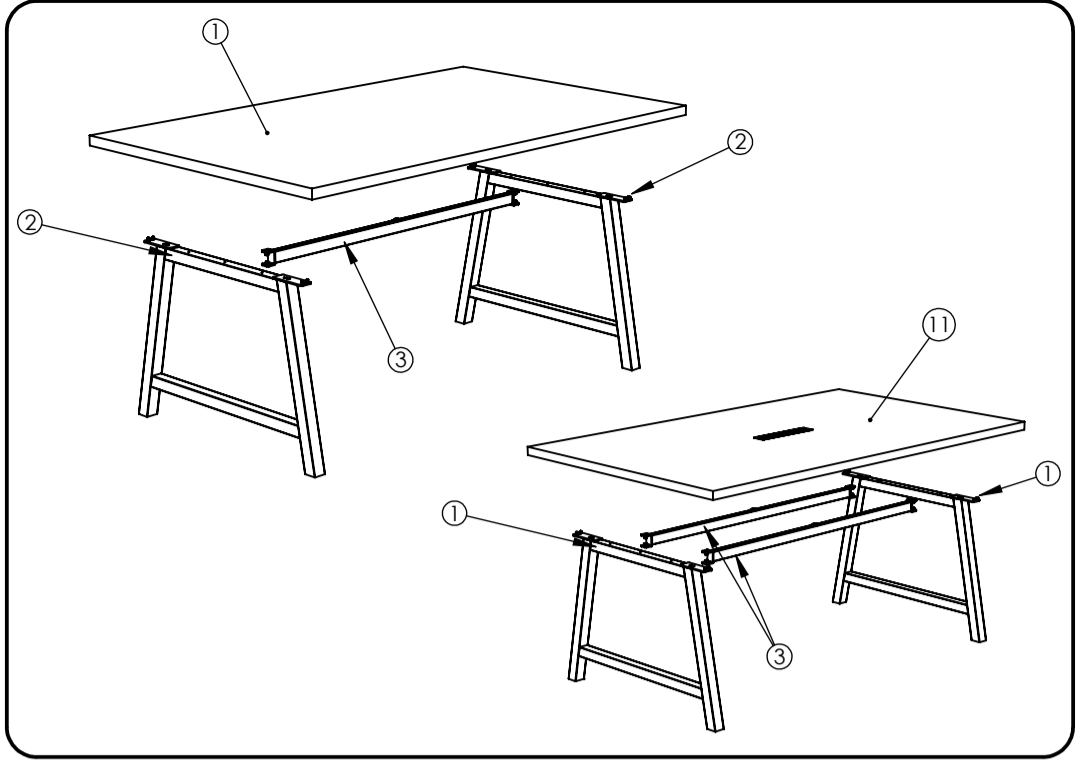

25 Mn

x1

ALCOOL A BRUZE
METHYLATED SPIRITS
BRANDSPIRITS
ESANHID
ALCOHOL DE QUEMAR
ALCOOL ETUICO

CHIFFON DOUX
SOFT RAG
LAPPEN
ZACHTE DOEK
FANNO MOROSO
FANNO SUAVE
FANO MACIO

SAYON
SOAP
SEIFE
SAPONE
JABON
SABAO

CIRE
WAX
WACHS
WAS
CERA

NOMENCLATURE (Parts list)
(Stückliste)
(Onderdelenlijst)
(Nomenclatura)
(Lista de peças)

Rep.	Pièce	Qté
1	PLATEAU 200x120	1
2	PIED 1000	2
3	POUTRE BUREAU 1400	1/2

QUINCAILLERIE (Hardware)
(Beschläge)
(Izerwaren)
(Ferramentas)
(Herrajes)
(Quinquilharia)

Rep.	Pièce	Qté	A	B	C
A	Vis TFHC M6x16	4			
B	VIS TBHC M6x16	4			
C	VIS Euro Lg 16mm	4			
D	Clé 6 pans 4mm	1			

AIDE
HELP
HILFE
HULP
AYUDA
AJUDA
AIUTO

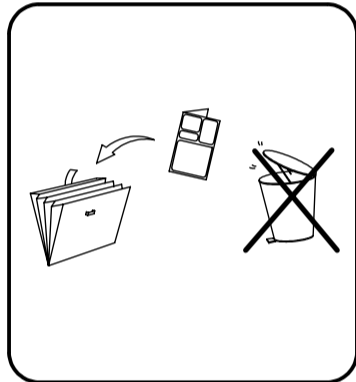

1

A x4/8
D x1

2

Option
Optioneel
Opzione
Opcional
Opção

J x1

B x4
C x4
D x1

3

Option
Optioneel
Opzione
Opcional
Opção

G x1
H x1

4

Option
Optioneel
Opzione
Opcional
Opção

E x2
F x16

NOTICE DE MONTAGE
INSTRUCTIONS FOR ASSEMBLY
MONTAGEANLEITUNG
GEBRUIKSAANWIJZING
ISTRUZIONI DI MONTAGGIO
INSTRUCCIONES DE MONTAJE
INSTRUCCOES DE MONTAGEM

buronomic

FABRICANT FRANÇAIS

N° DV40877

CONCEPTION ET REALISATION BUREAU D'ETUDES BURONOMIC

GARANTIE (vices caches)
_ Référence produit à nous communiquer impérativement en cas de litige :
Voir étiquette apposée au dos du produit

GARANTEE (defekt)
_ In the event of complaint, it is essential to mention the product reference :
See label affixed to the back of the product.

GARANTIE (fabrikationfelher)
_ Im streitfall sit uns die produktreferenz mitzuteilen :
Siehe etikett auf produktruckseite.

WAARBORG (de verborgen gebreken)
_ Vermeld in geval van klachten altijd het productnummer :
Zie label op de achterzijde van het product

GARANZIA (vizi occulti)
_ Specificare obbligatoriamente il riferimento prodotto in caso di contestazioni :
Si veda l'etichetta applicata dietro il prodotto

GARANTIA (defectos ocultos)
_ Referencia de producto citese obligatoriamente en caso de reclamacion :
Ver etiqueta en la parte posterior del producto.

GARANTIA (vicios ocultos)
_ Em caso de reclamacao indiqu-nos imperativamente a referencia do produto :
Ver etiqueta fixada na parte posterior do produto

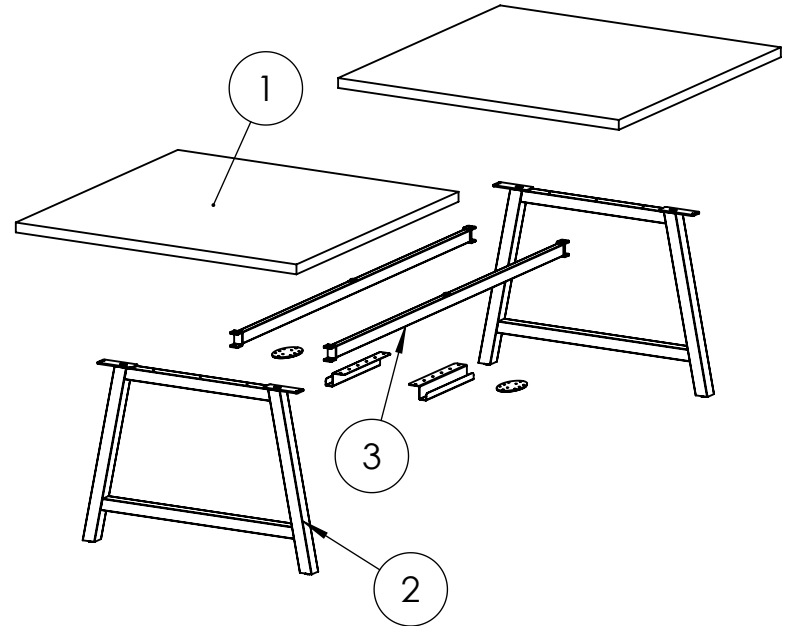
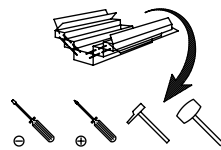
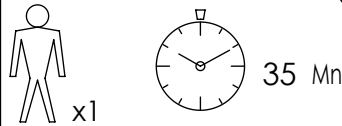
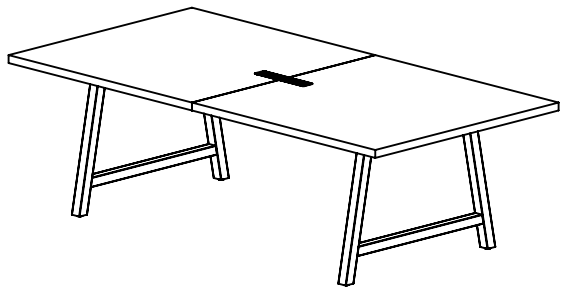
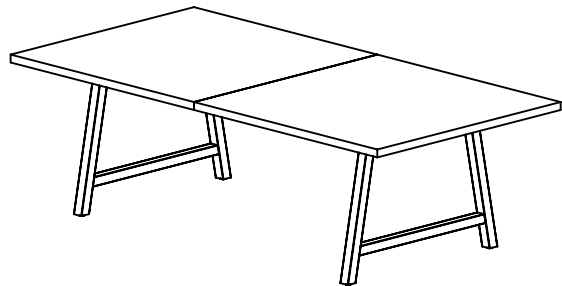

NOMENCLATURE

(Parts list)
(Stückliste)
(Onderdelenlijst)
(Nomenclatura)
(Lista de peças)

Rep.	Pièce	Qté
1	PLATEAU	2
2	PIED 1000	2
3	POUTRE BUREAU 1800	2

QUINCAILLERIE

(Hardware)
(Beschiège)
(Ijzerwaren)
(Ferramentas)
(Herrajes)
(Quinquilharia)

Rep.	Pièce	Qté	A	B	C
A	Plaque de jonction	2			
B	Raidisseur de Liaison	2			
C	VIS TBHc M6x16	8			
D	Vis TCB 5x20	16			
E	VIS Euro Lg 16mm	12			
F	Vis TFHC M6x16	8			
G	Entretoise adhésive	2			
H	Clé 6 pans 4mm	2			

AIDE

HELP
HILFE
HULP
AYUDA
AJUDA
AIUTO

